



## SPECIFICATIONS

### 1 General

Part Number	Description
70.9M110C50	70.9MHz Crystal filter, DIP package

### 2 Revision History

Revision	Released	Revision Detail
R1	2020-7-31	Initial release

### 3 Electrical Specification

Item	Typical
Nominal Frequency (Fc, MHz)	70.9±0.002
Insertion Loss (dB)	≤4.0
Ripple Within Pass Band (dB)	≤1.0
Bandwidth at -3dB (kHz)	≥110
Attenuation (at Fc±100kHz~±299.9kHz, dBc)	≥40
Attenuation (at Fc±300kHz~±499.9kHz, dBc)	≥60
Attenuation (at Fc±500kHz~±10MHz, dBc)	≥70
Attenuation (Outside Fc±10MHz, dBc)	≥65
Phase Consistency (°)	≤±15
Phase Stability (°)	≤3
Amplitude Consistency (dB)	≤1.5
VSWR (Fc±55kHz)	≤2.0
I/O Impedance (Ω)	50
Group Delay Absolute at Fc (us)	14±2
Group Delay Variance at Fc±20kHz (us)	8
Operation Temperature (°C)	-40 ~ +70
Storage Temperature (°C)	-45 ~ +75
Package Size (mm)	36x14x10

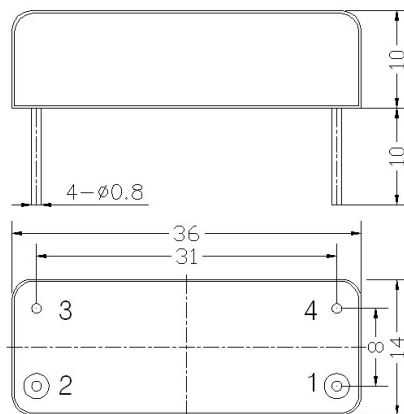

Bottom View

Pin No.	Description
1	Input/Output
2	Output/Input
3,4	Ground

Unit:mm